

**MASTER  
TECHNICIANS  
SERVICE  
CONFERENCE  
REFERENCE  
BOOK**

**69-6**

**IGNITION  
SYSTEM  
ANALYSIS**

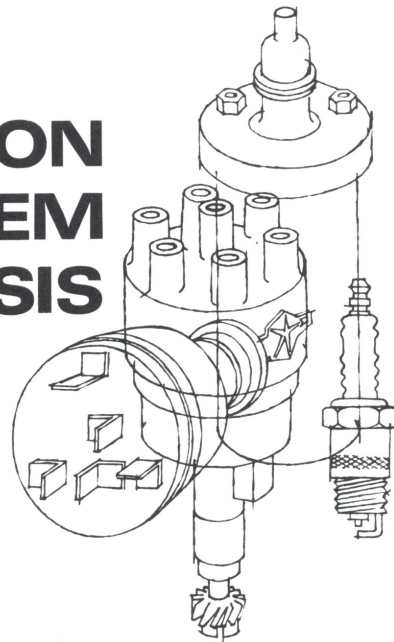

**PLYMOUTH  
DODGE  
CHRYSLER  
IMPERIAL  
DODGE TRUCK**



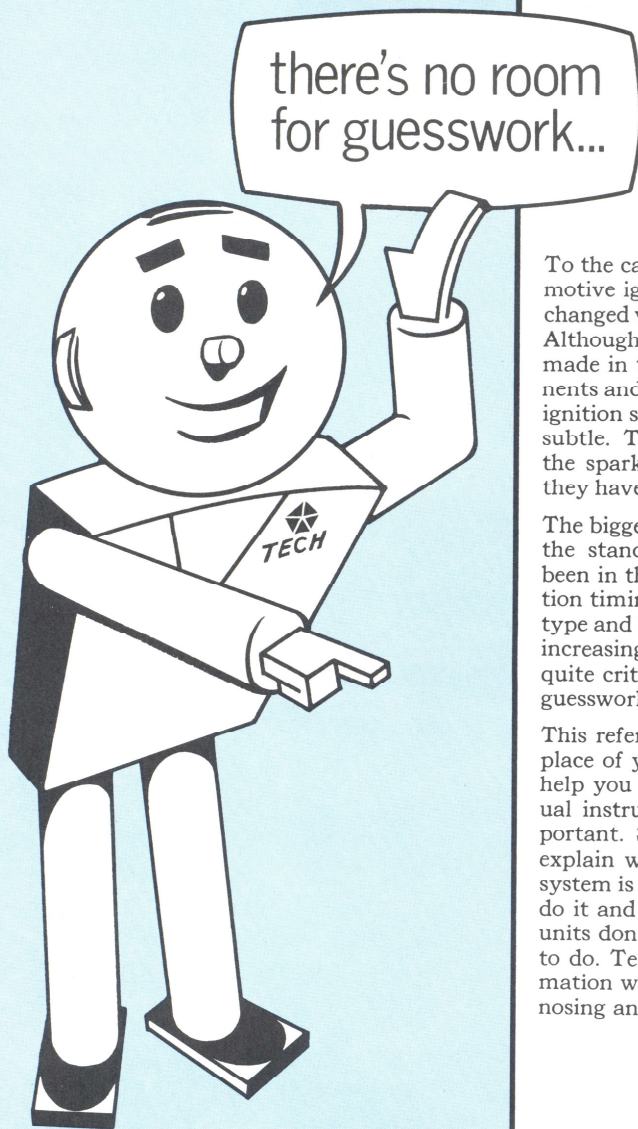

To the casual observer, the conventional automotive ignition system doesn't appear to have changed very much in the past five or ten years. Although changes and refinements have been made in the design of ignition system components and new materials have been introduced, ignition system improvements have been quite subtle. The ignition coil, the distributor and the spark plugs look very much the same as they have for quite a few years now.

The biggest and most important changes, from the standpoint of engine performance, have been in the area of service specifications. Ignition timing, distributor calibration, spark plug type and heat range, for example, have become increasingly important and in some instances, quite critical. As a result, there is no room for guesswork when servicing the ignition system.

This reference book isn't intended to take the place of your Service Manuals. Rather, it will help you understand why those Service Manual instructions and specifications are so important. Specifically, the pages which follow explain what each component of the ignition system is supposed to do, why it is supposed to do it and what happens when ignition system units don't do exactly what they are supposed to do. Tech is sure you'll find that this information will help you do an expert job of diagnosing and servicing the ignition system.

**TABLE OF CONTENTS:**

WHAT THE IGNITION SYSTEM MUST DO . . . . .	1
THE PRIMARY PART OF THE IGNITION SYSTEM . . . . .	2
THE SECONDARY PART OF THE IGNITION SYSTEM . . . . .	10

## WHAT THE IGNITION SYSTEM MUST DO

For openers, let's take time to review the things that the ignition system must do to contribute to good engine performance. The ignition system is a voltage booster. It must convert the low voltage available at the storage battery to the high voltage required at the spark plug to fire the mixture in the combustion chamber.

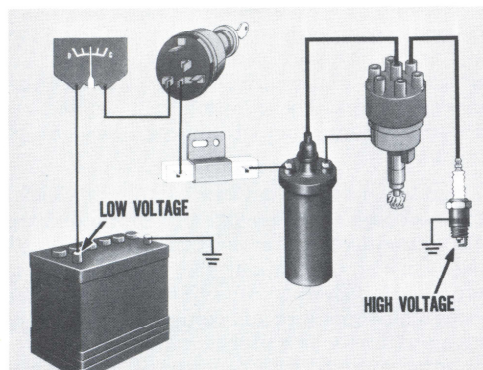

Fig. 1—Ignition system changes low voltage to high voltage

### TIMING IS PART OF THE JOB

Providing high voltage at the spark plug is only part of the ignition system's job. It must also send that high voltage to the right spark plug at the right time. In addition, it must control the timing of the spark for best engine performance under a wide variety of operating conditions. That's a pretty big order when you stop to consider that the ideal time for igniting the air-fuel mixture changes every time engine speed or the load on the engine changes.

### THE PRIMARY STARTS AT THE BATTERY

The low voltage or primary circuit starts at the battery and includes the ammeter, the ignition switch, the ballast resistor, the primary winding of the ignition coil, the condenser, the distributor contacts and the connecting wires.

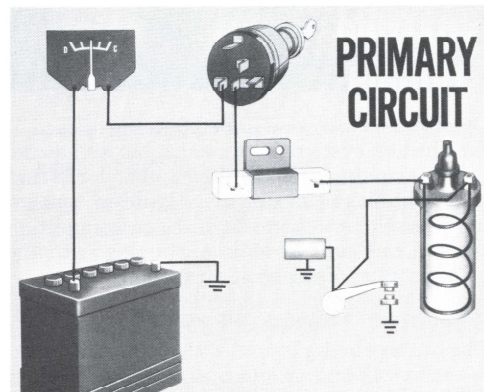

Fig. 2—Diagram of the ignition primary circuit

### THE SECONDARY STARTS AT THE COIL

The secondary or high-voltage circuit begins at the secondary winding of the ignition coil. This circuit includes the secondary ignition cables, the distributor cap, the distributor rotor and the spark plugs.

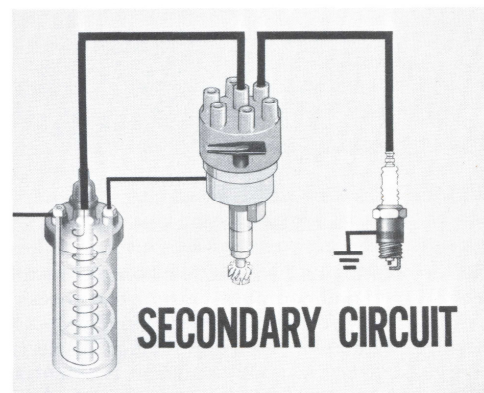

Fig. 3—Diagram of the ignition secondary circuit

In other words, two units in the ignition system contain part of the primary circuit and part of the secondary circuit. The coil contains both secondary and primary windings. Distribution of the high-voltage secondary current is actually the simplest part of the distributor's job. Timing the ignition by controlling the primary current is the much more complex job performed by the distributor. But we'll go into that in greater detail later.

## THE PRIMARY PART OF THE IGNITION SYSTEM

Once you have a good understanding of each of the ignition system components, as well as the possible malfunctions of these units, you'll find it a lot easier to diagnose ignition system troubles. So let's go through the entire ignition system, one unit at a time, starting with the primary part of the ignition system.

### THE BATTERY PROVIDES THE POWER

The battery is the source of electrical power for cranking the engine and operating the ignition system. It also provides the power for the lights and the electrical accessories.

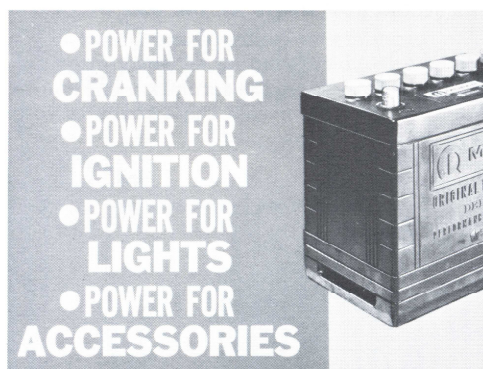

Fig. 4—The battery supplies the electrical power

Battery testing and service is a complete subject in itself and complete battery test specifications and procedures are covered in your Service Manuals. However, since a fully charged battery in good condition is essential to good ignition system performance, the battery should be tested and inspected as part of every engine tune-up or ignition service job.

### BATTERY CONDITION AND TESTING

There are four common causes of battery trouble: a cracked or damaged case, prolonged undercharging or overcharging, neglected maintenance and periodic service and installation of an under-capacity battery. Whatever the reason, a battery that is in poor condition is bound to cause both starting and ignition performance problems.

- CRACKED CASE OR COVER
- UNDERCHARGING OR OVERCHARGING
- NEGLECTED MAINTENANCE
- UNDER-CAPACITY BATTERY

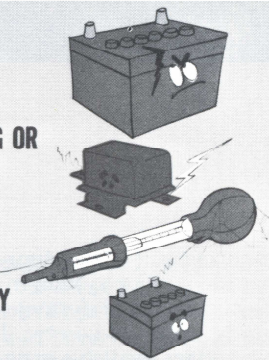

Fig. 5—Four common causes of battery trouble

External appearances can be misleading, so don't take battery condition for granted . . . particularly when you're dealing with a starting or performance problem. In view of the wide variety of dependable battery test equipment available, the question isn't whether or not to test, but rather which type of test equipment to use.

The introduction of batteries with solid, rather than soft-sealed, tops virtually eliminated the open-circuit voltmeter method of battery testing. This brought about the development of the Cad-Tip Battery Analyzer and similar devices which measure and compare cell voltages by inserting the test probes into the electrolyte of adjacent cells. Another type of battery test equipment in common use is Battery Load Tester. This type of equipment tests the battery's ability to provide power for engine cranking and starting and quickly determines whether or not the battery is still serviceable. Whatever your choice of battery test equipment, complete instructions for using it are supplied by the equipment manufacturer.

### THE OLD RELIABLE HYDROMETER

Temperature-corrected, specific gravity readings provide a simple, reliable means of determining battery condition and state of charge. The hydrometer indicates the state of charge by measuring specific gravity or concentration of acid in the electrolyte. More acid makes the float ride higher in the electrolyte drawn up by the hydrometer.

A specific gravity reading in each cell of about 1.220 means the battery is charged and prob-

ably in good condition. If cell readings average 1.220, the battery is approximately three-quarters charged. A specific gravity of 1.215 or less in all cells means that the battery must be recharged and retested. If it is necessary to add water to the battery, allow plenty of time for it to mix thoroughly with the electrolyte before taking specific gravity readings.

#### TEMPERATURE IS IMPORTANT, TOO

Be sure and use the thermometer built into the hydrometer and make the necessary temperature corrections to make sure your specific gravity readings are accurate. This is important because there is only .045 gravity points difference between a fully charged battery and one that needs recharging.

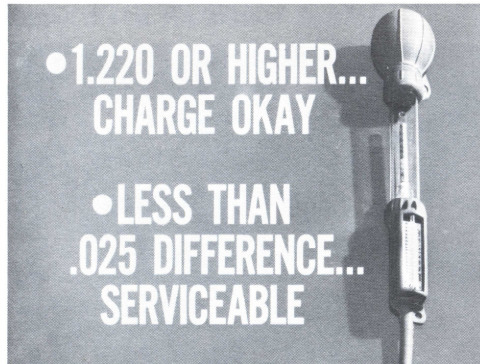

Fig. 6—Use temperature-corrected specific gravity readings

Most hydrometer floats are calibrated for direct-reading when the electrolyte is at 80 degrees Fahrenheit. For each 10 degrees above 80, you must add .004 to your reading because electrolyte expands and gets thinner as it warms up. Deduct .004 from your float reading for every 10 degrees below 80 degrees.

#### BIG DIFFERENCES MEAN TROUBLE

One of the most significant things to note when testing a battery is differences in readings between cells. If the electrolyte in any cell reads .025 points lower than the highest reading cell, there is a good chance that the low reading cell is damaged or worn out. Use your battery load tester to find out whether the battery can be saved or is indeed unserviceable.

On the other hand, if the difference between

cells is less than .025, the battery is probably in serviceable condition. If the specific gravity readings are lower than 1.220 but uniform within .025 points, the battery is in good condition and only needs to be charged.

#### A WORD ABOUT THE ODD ONES

Battery acid-water mixtures are adjusted by the manufacturer to do the best job with the least possible wear and tear on the battery plate material. Under unusual operating conditions you may encounter batteries with specific gravity readings as high as 1.280 or as low as 1.250 when fully charged. High specific gravity batteries provide extra cranking power and are usually intended for climates which are consistently very cold. However, since high specific gravity tends to reduce battery life when used in warmer climates, low gravity batteries are commonly used in geographic areas where year-round warm temperatures provide easy starting. Incidentally, unless you are a trained battery technician, don't get any ideas about adding acid to a battery to get more cranking power. Handling sulfuric acid is dangerous and amateur adjustment of battery acid will probably ruin the battery.

#### THE COIL PRODUCES THE PUNCH

The ignition coil utilizes the principle of induction to increase the low voltage available at the battery to the high voltage required to jump the spark plug gap. Under operating conditions, the actual output voltage of the coil is determined by the amount of voltage needed to cause the spark to jump the plug gap.

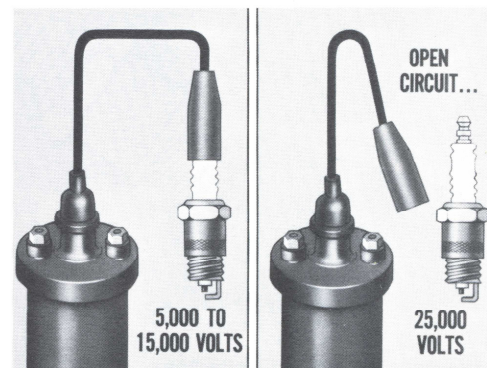

Fig. 7—Secondary voltage varies with operating conditions

This varies from about 5,000 volts at idle speed to about 15,000 volts at higher speeds. That's why a marginal ignition system may provide adequate ignition at low speed but result in engine miss at higher speeds.

Maximum coil voltage is reached under open-circuit conditions. If, for example, the coil secondary cable is disconnected from the distributor or the coil and is not grounded, secondary voltage may go as high as 25,000 volts. That's why you should never crank the engine with the secondary coil ignition cable disconnected. The high open-circuit voltage will try to jump from the coil secondary winding to the primary winding. This can puncture the insulation and damage the coil.

#### TO KEEP THE ENGINE FROM STARTING

If, for any reason, you want to keep the engine from starting when it is cranked, disconnect the primary ignition wire from the distributor side of the coil. Don't disconnect the battery lead from the coil because it is "hot" whenever the ignition is on and will cause "fireworks" if it accidentally touches a ground. Using a ground jumper at the coil to short out the primary isn't a good idea either. If the jumper remains connected more than a few minutes the coil may be overheated and damaged . . . play it safe and disconnect the "DIST" primary lead.

#### COIL POLARITY IS MIGHTY IMPORTANT

The importance of correct ignition coil polarity is often overlooked or misunderstood. The ignition spark jumps the gap at the spark plug

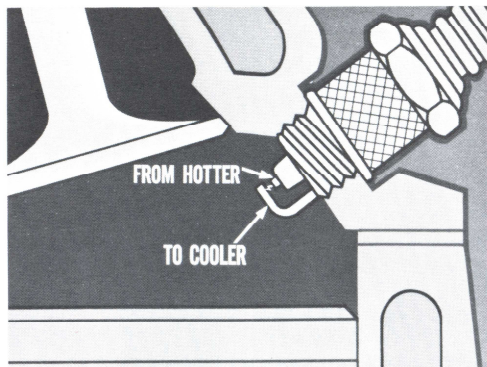

Fig. 8—Spark jumps more easily from hot to cold

much more easily when the electron flow is from the hotter center electrode to the cooler ground electrode. Reversing the primary connections at the coil causes the spark to jump from the ground electrode to the hot center electrode. As much as 40% higher voltage is required to jump the spark in this direction.

Actually, there is no excuse for connecting the coil incorrectly . . . but it does happen. The lead from the ballast resistor must be connected to the coil terminal marked "BAT" (+) and the distributor lead should be connected to the terminal labeled "DIST" (-). Incidentally, if you are using an oscilloscope to check the ignition system and the pattern is upside-down, check the primary connections at the coil. Either these connections are reversed or the oscilloscope isn't connected correctly.

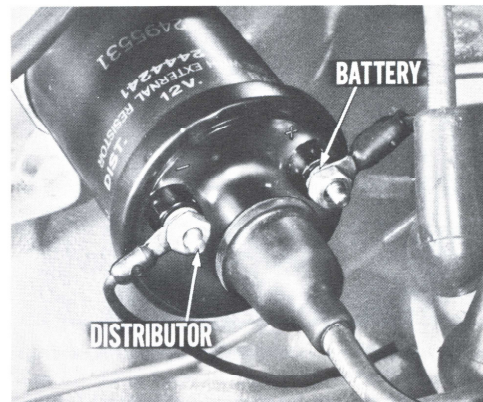

Fig. 9—Be sure and connect coil for correct polarity

#### ABOUT THAT BALLAST RESISTOR

A ballast resistor is connected in series in the primary circuit between the ignition switch and the ignition coil. It is so connected that when the ignition key is turned all of the way to the cranking position, the primary ignition circuit bypasses the ballast resistor to provide the hottest possible spark for easy starting. This is particularly important in extremely cold weather because the heavy cranking load on a cold engine reduces available primary voltage. This, in turn, reduces secondary voltage. The ignition "start" circuit bypasses the ballast resistor so that voltage while cranking is not reduced still more.

As soon as the engine starts and the ignition key is allowed to return to the "run" position, the primary ignition circuit is routed through the ballast resistor. The ballast resistor stays relatively cool at higher speeds and offers relatively low resistance to current flow. This provides the extra margin of ignition voltage needed for good performance at higher speeds.

At lower engine speeds the ballast resistor gets much warmer and its resistance increases. This limits primary voltage and reduces current flow at low speed which reduces arcing across the ignition points and thus increases the life of the ignition points. Reducing current flow at low speeds also lowers coil operating temperatures, reducing the possibility of premature coil breakdown.

#### **DON'T BYPASS THE BALLAST RESISTOR**

Don't make the mistake of trying to cure an ignition problem by using a jumper to bypass the ballast resistor. Eliminating the ballast resistor won't improve ignition for starting because the start circuit bypasses the resistor anyway. Bypassing the ballast resistor may provide higher voltage and a hotter spark at low speeds, when it's not really needed, but will do little if anything to improve ignition performance at higher speeds. About all the extra current flow will do is promote ignition point arcing and materially reduce point life.

#### **THE CONDENSER DOES DOUBLE DUTY**

The condenser is connected in parallel across the ignition points. It helps the coil develop higher voltage because it speeds up the collapse of the magnetic field. It also increases ignition point life because it reduces arcing across the points as they open.

Condenser failure is not a common cause of ignition trouble. Of course, if a condenser should short out there would be no ignition at all. An open condenser would result in a very weak spark, hard starting, misfiring and arcing and burning of the ignition points. The condenser must be matched to a specific coil and ignition system. An over-capacity or under-capacity condenser will reduce ignition performance and result in burned ignition points. The only sure way to test a condenser is with a condenser tester. Although condensers seldom fail, it has become almost universal

practice to replace the condenser whenever points are replaced. Most owners, and many technicians, feel that the relatively small cost of a new condenser is good ignition performance insurance. It shouldn't be necessary to install a new condenser when points are replaced, however it's pretty difficult to buck the established "points-and-condenser" philosophy. Play it safe and test the condenser, new or original, before you install it.

#### **THE PRIMARY PART OF THE DISTRIBUTOR**

The distributor contains part of the primary circuit and part of the secondary circuit. Its function in the primary circuit is to close and open the circuit so that a high voltage will be induced in the ignition coil. Its secondary circuit function is to deliver the high voltage to the spark plugs in the correct firing order. The ignition points, in the primary part of the circuit, actually determine ignition timing. Ignition timing requirements depend upon engine speed and the load on the engine. And, of course, engine speed and load change every time the driver moves the accelerator. That's why the centrifugal and vacuum advance mechanisms are needed.

#### **IGNITION TIMING DEPENDS ON:**

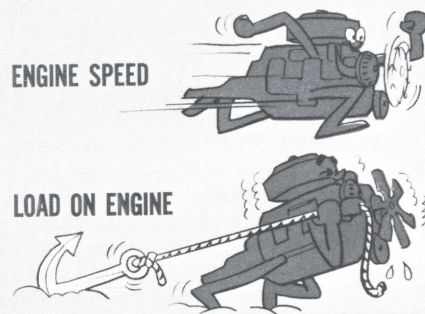

Fig. 10—Timing requirements change with speed and load

#### **CENTRIFUGAL ADVANCE REACTS TO SPEED CHANGES**

As engine speed increases, the time available to burn the mixture in the cylinders decreases. The centrifugal advance mechanism in the distributor automatically adjusts timing so that the mixture is ignited earlier. This gives the mixture time to burn completely during the power stroke.

The centrifugal advance curve is carefully calibrated in production to provide the correct amount of ignition advance as engine speed increases. However, if there is any reason to question the operation of the centrifugal advance, use a reliable distributor test bench to check it.

#### VACUUM ADVANCE REACTS TO LOAD CHANGES

Under some operating conditions the centrifugal advance doesn't ignite the mixture soon enough to insure complete combustion. For example, under part throttle and light load conditions, the air-fuel mixture isn't as highly compressed as it is at wide-open throttle. Since the fuel particles aren't packed as tightly together it takes longer for the flame to travel from one particle to the next.

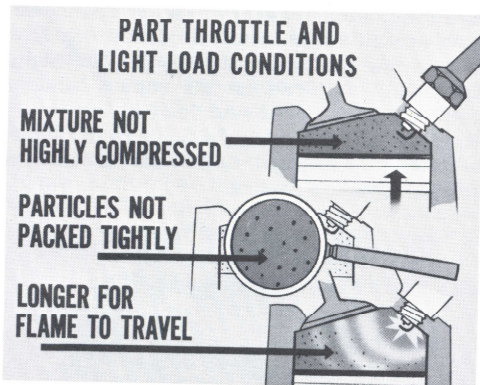

Fig. 11—Slower combustion requires earlier ignition

Because the combustion process is slower under part-throttle and light-load conditions, the mixture must be ignited sooner so that all of the fuel will be burned before the completion of the power stroke. The vacuum advance unit takes care of this little detail.

#### VACUUM MOVES THE BREAKER PLATE

The vacuum advance diaphragm is linked directly to the movable breaker plate. Vacuum, acting on the spring-loaded diaphragm, rotates the breaker plate against the direction of distributor cam rotation. This causes the breaker points to open sooner so spark timing is advanced. For example, on a level road under part-throttle cruising conditions, vacuum is high and this advances the spark for maximum

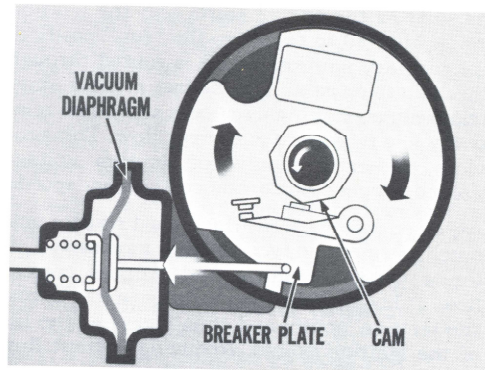

Fig. 12—High engine vacuum moves the breaker plate

efficiency and economy. Of course, this is in addition to the centrifugal advance provided at cruising speed.

If the throttle is suddenly opened wide, vacuum decreases and the spring-loaded diaphragm quickly moves the breaker plate back toward the "no advance" position. This is desirable because at open throttle the mixture is more highly compressed and the fuel particles are packed closer together. As a result, the mixture burns faster so less spark advance is needed for complete combustion.

#### NO VACUUM ADVANCE AT IDLE SPEED

Vacuum is relatively high at idle but vacuum advance is not required to insure complete combustion. To eliminate vacuum advance at idle, the vacuum source for the advance unit is a port located in the carburetor throttle

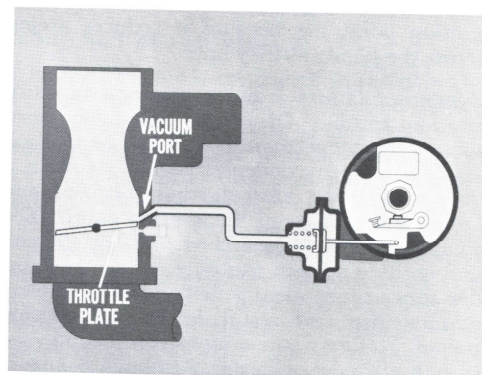

Fig. 13—Vacuum advance port location above throttle



bore. This port is located just above the throttle when the throttle is in the closed position.

#### ENGINE IDLE AFFECTS IGNITION TIMING

If engine idle speed is higher than specified, the vacuum advance port will be partially uncovered. This will result in some unwanted vacuum advance at idle. To make matters worse, higher than specified idle speed also causes some unwanted centrifugal advance. If carburetor idle speed and mixture adjustments aren't correct, ignition at closed throttle will be advanced and the engine will tend to race instead of coming down to idle when the throttle is released.

#### DISCONNECT THE VACUUM LINE TO SET TIMING

Before checking or adjusting basic timing, disconnect the vacuum line from the vacuum advance unit. Plug the end of the disconnected vacuum line or the vacuum leak will cause the engine to stall. Disconnecting the vacuum line is the best way to make sure unwanted vacuum advance doesn't result in a false basic timing indication.

After setting or checking basic timing, but before reconnecting the vacuum line, speed up the engine and watch the timing mark. Timing should advance as engine speed is increased. This doesn't take the place of bench-testing distributor calibration, but it does assure you that the centrifugal advance unit is working.

#### RECONNECT THE VACUUM ADVANCE LINE

Before you disconnect the timing light, reconnect the vacuum line and recheck the timing. There should be no timing change or advance with the line connected. If the timing advances at idle, recheck the carburetor mixture and idle speed adjustments to find out why vacuum advance is coming at idle.

#### DON'T ABUSE THE VACUUM ADVANCE UNIT

Be mighty careful how you go about disconnecting or connecting the vacuum advance line to the vacuum advance unit. A careless yank or push can spring things enough to affect the calibration of the vacuum advance.

Incidentally, if the diaphragm in the vacuum advance unit is punctured, both economy and performance will suffer. If you encounter either of these complaints, test the diaphragm by applying vacuum to the advance unit.

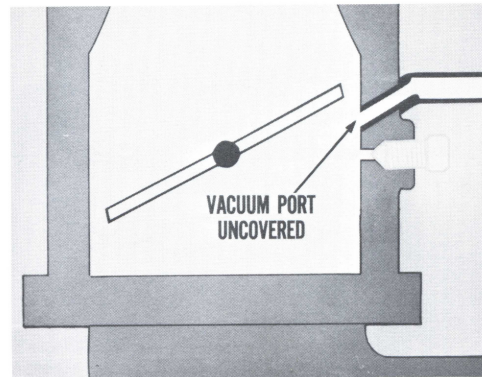

Fig. 14—Testing the vacuum advance diaphragm

Probably the easiest way to do this is to simply apply mouth suction to vacuum inlet.

You can do this by disconnecting the line at the carburetor or you can remove the distributor from the car to check it. In either case, it isn't difficult to apply enough vacuum to see if the breaker plate moves and holds without leaking. The breaker plate should snap back when the suction is released. On current model distributors, breaker plate travel is quite limited, so don't expect much movement. The mouth method of testing a diaphragm may not sound scientific but it really works; it will spot even a slight leak and can be accomplished in less time than it takes to tell.

#### BASIC TIMING IS TERRIBLY TOUCHY

On today's engines it is very important to set basic timing exactly to specifications. A few years back, most engines would tolerate a moderate amount of deviation from specifications to compensate for fuel octane and other variables. Current models simply won't tolerate tinkering with the timing. Use the recommended fuel grade and set timing right on the specified button.

#### POINT GAP AFFECTS TIMING

Here's something that's sometimes overlooked. Because point gap and dwell affect timing as well as secondary voltage, timing must be rechecked whenever point gap is adjusted.

If contact point gap is too wide, the points open sooner so ignition timing is actually advanced. Besides, dwell is reduced and this de-

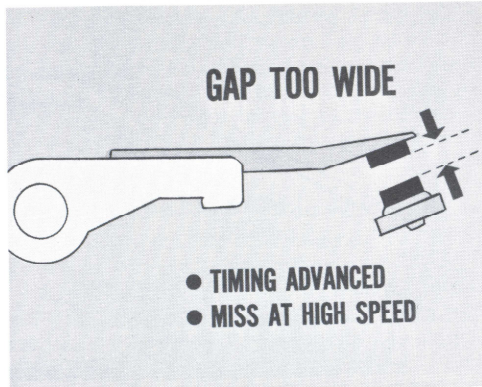

Fig. 15—Wide point gap reduces the dwell angle

increases secondary voltage, causing a miss at higher engine speeds.

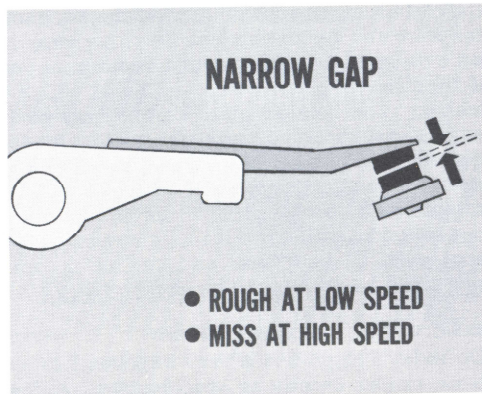

Fig. 16—Narrow point gap affects engine performance

On the other hand, a narrow point gap increases dwell. This may result in rough engine operation at low speeds and increased arcing and point burning. Double-check yourself after installing new points by checking dwell to make sure it is within specifications.

#### HOW GOOD IS THE IGNITION SPARK?

Frequently, on hard-starting or rough-engine operation complaints, the technician doesn't know whether to start by checking ignition or tackling carburetion first. Spark intensity provides a quick clue to possible ignition troubles and can often tell the experienced technician

whether to tackle the ignition system or the fuel system first.

To check spark intensity, simply remove a plug cable from one plug, stick a conductor into the terminal and hold the conductor  $\frac{3}{8}$  of an inch or so from a good ground. Crank the engine and observe the spark.

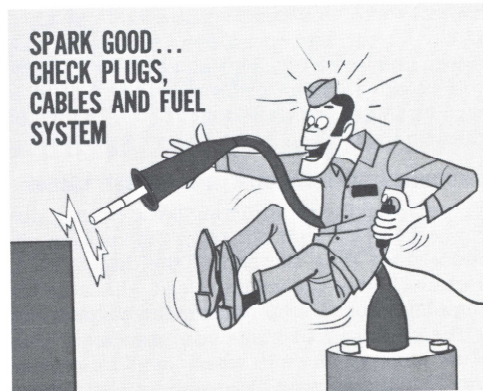

Fig. 17—Test ignition spark intensity

If the spark is good and jumps the gap easily, the basic ignition system is probably okay. If the complaint is hard starting, won't start or a miss, you better check the spark plugs, secondary cables and then the fuel system.



Fig. 18—If spark is weak, check primary circuit resistance

On the other hand, if the spark is very weak or won't jump at least a  $\frac{3}{8}$ -inch gap, you'll know you have ignition trouble. In that case,

a good place to start looking for trouble is in the ignition primary circuit.

#### CHECK VOLTAGE WHILE CRANKING

High resistance anywhere in the primary circuit will reduce voltage available and cause ignition problems. Probably the quickest and easiest way to determine whether primary voltage available at the ignition coil is okay is to make a cranking voltage test. To do this, disconnect the primary lead from the distributor "DIST" (-) side of the ignition coil to keep the engine from starting when it is cranked. Next, connect the positive lead of a voltmeter to the battery "BAT" (+) side of the ignition coil and the other voltmeter lead to ground.

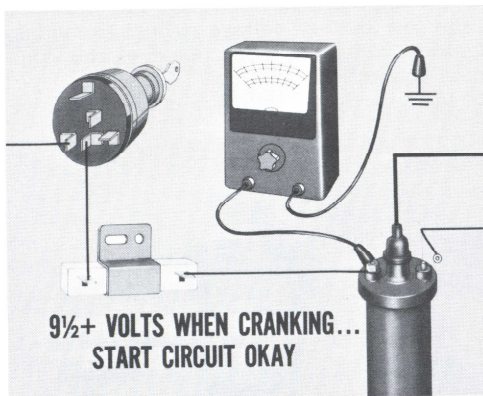

Fig. 19—Connections for the cranking voltage test

Crank the engine and watch the voltmeter. If the voltage while cranking a warm engine is  $9\frac{1}{2}$  volts or higher, the "start" part of the ignition circuit is okay. The voltage while cranking specification is actually 9.6 volts but for all practical purposes  $9\frac{1}{2}$  volts is about as close as you can read most automotive voltmeters.

If cranking voltage is less than  $9\frac{1}{2}$  volts and you're sure the battery is okay, the trouble is either in the starting motor or it's high resistance in the primary ignition circuit.

#### CHECK FOR VOLTAGE DROP

There are two ways of testing for high resistance or voltage drop. You can measure the voltage at each terminal or connection and compare the reading at one terminal with the

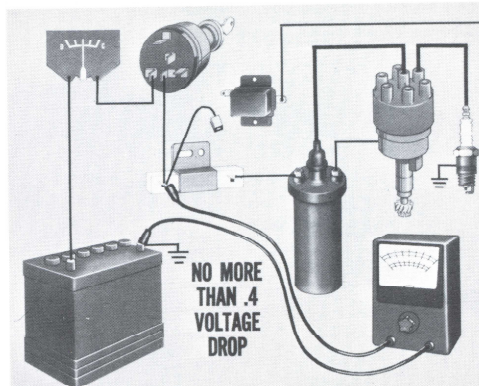

Fig. 20—Voltmeter connected to check voltage drop

reading at the previous terminal . . . the difference is the voltage drop. With today's insulated connectors, it's a lot easier to connect the voltmeter across the circuit and read the voltage drop directly.

To check for resistance between the battery and the ballast resistor, connect a voltmeter across the circuit from the ignition switch end of the ballast resistor to the positive battery post. You should also disconnect the voltage regulator to eliminate current flow in that circuit. That's because the alternator field circuit branches off of the ignition circuit and the extra flow could heat up the ignition circuit, cause increased resistance and give you a higher than normal voltage drop reading.

With ignition on and ignition points closed, the voltage drop should not be more than .4 of a volt. If the drop is greater than that, you'll have to make a point-by-point check to find the point of high resistance.

Because most of the connections and terminals in the circuit are not readily accessible, it is difficult to make a point-by-point check by moving the voltmeter leads. For example, it is much easier to leave the voltmeter connected across the circuit between the ballast resistor and the battery positive terminal. Also, leave the ignition on and the ignition points closed. Next, check each connection and terminal by simply wiggling it while you watch the voltmeter. Be sure and check connections at the bulkhead disconnect. If wiggling the wire or connector causes the voltmeter needle to jump,

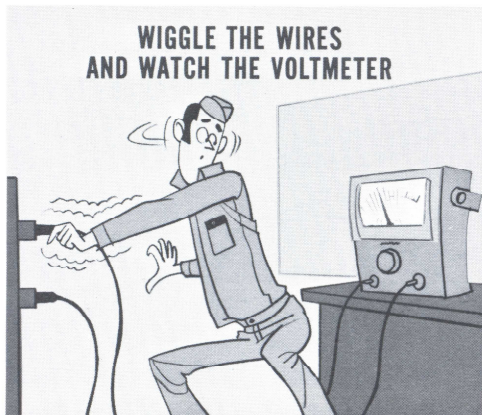

Fig. 21—If the needle jumps, you've located trouble

you'll know that connection isn't a good one and could be the cause of ignition trouble.

#### CHECK THE IGNITION SWITCH, TOO

Don't forget to check for resistance in the ignition switch. Turn the switch off and on several times. The meter needle should come back to the same reading each time the switch is turned on. For good measure, wiggle the ignition key. The voltmeter needle should not jump. If it does, you probably have ignition switch contact trouble.

#### DISTRIBUTOR POINTS AND GROUND CIRCUIT

To check for resistance between the distributor "DIST" (-) side of the ignition coil and ground, connect the voltmeter across the circuit from the distributor "DIST" (-) terminal to the battery ground terminal. With ignition points closed and the ignition switch on, the voltage drop should not be more than .1 of a volt. If the drop is greater, check for burned or glazed distributor point contacts.

There is a good chance that a drop of more than .1 of a volt is in the battery ground cable connections or poor electrical contact between the distributor and the engine block. To check this out, move the voltmeter lead from the battery ground post to the distributor housing. If the drop is still more than .1 of a volt, the trouble is in the distributor or primary lead from the coil. If it is less than .1 of a volt, you have ground cable or distributor-to-engine block resistance.

## THE SECONDARY PART OF THE IGNITION SYSTEM

The ignition system secondary circuit starts at the secondary winding of the ignition coil, includes the distributor cap and rotor, the secondary ignition cables and the spark plugs.

#### THE IGNITION COIL

The ignition coil forms the connecting link between the primary and the secondary ignition circuits. To simplify construction, the secondary winding of fine wire and the primary winding of heavy wire have a common junction at the battery "BAT" (+) terminal of the ignition coil. However, the transition from low battery voltage to high secondary ignition voltage is independent of this common connection. The high voltage developed in the secondary winding is purely inductive.

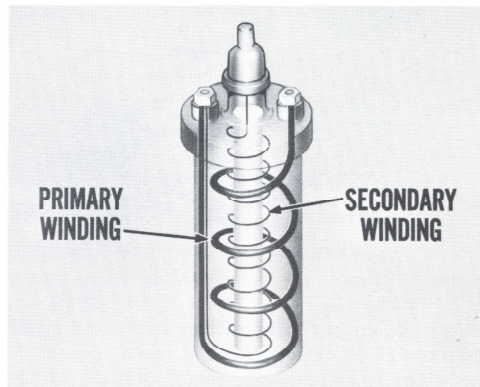

Fig. 22—The ignition coil contains two windings

As was pointed out earlier, the condenser speeds the collapse of the field and this in turn increases the voltage induced in the secondary windings. But let's see how the current flow produced by this voltage gets to the plugs.

#### DISTRIBUTOR CAP AND ROTOR

The distributor cap and rotor are nothing more than a sequence switch. The towers of the distributor cap are arranged in the firing order of the engine so that the rotor completes the secondary circuit to the spark plug cables in the correct order.

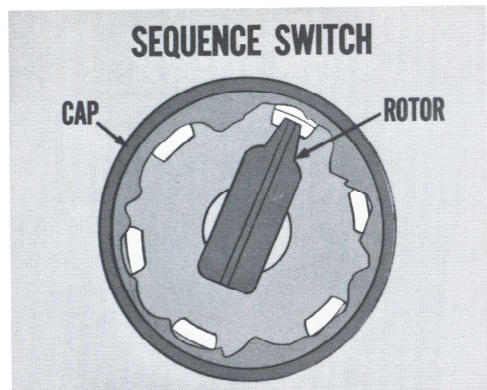

Fig. 23—The cap and rotor work like a switch

#### INSPECT THE CAP AND ROTOR

Corroded terminals or cracks are the most common kinds of distributor cap trouble. A visual inspection will usually disclose these conditions. A distributor cap seldom develops a crack all by itself when installed on the distributor. The surest way to damage a cap is to drop it. A good bump on the edge of the cap when it is off the distributor can easily crack it, so handle that distributor cap with care. Carbon tracking and hairline cracks are difficult to see, so if you have a miss or cross-firing, look that cap over very carefully.

As a matter of routine inspection, try to wiggle the rotor with your fingers to make sure it fits snugly on the distributor shaft. A visual inspection is all that is needed to spot a pitted or burned rotor.

#### THE SPARK PLUG STARTS THE FIRE

The spark plug provides the gap across which the high voltage in the secondary circuit discharges a spark to ignite the mixture in the combustion chamber. The heat range of the spark plug depends primarily on the length of the insulator tip.

A spark plug with a long tip transfers heat to the cooling system slowly so it operates at a higher temperature and is called a "hot plug". A plug with a short insulator tip gets rid of the heat much faster and is called a "cold plug". Notice in the cutaway illustration of a hot and a cold plug that the actual distance that the tip extends from the plug is the

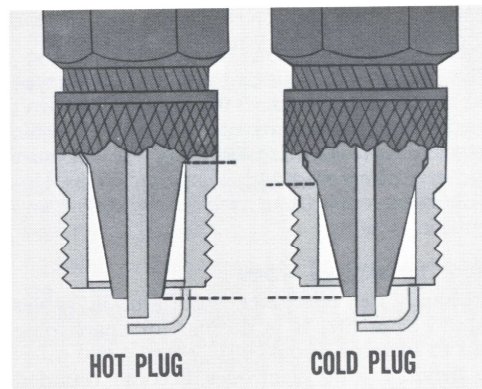

Fig. 24—Plug heat range depends on insulator tip length

same. However, the distance from the insulator tip to the point where the insulator contacts the metal spark plug shell is much longer on the hot plug than it is for the cold plug. Play it safe and check to make sure you have the correct type and heat range for the engine you are working on.

#### SOMETIMES RESISTANCE IS GOOD

An ignition system in good condition can produce more ignition energy than is actually needed for good ignition. This provides an extra margin of ignition output to insure good performance under all operating conditions. Unless it is controlled, this extra electrical energy will cause radio interference and will shorten spark plug life. That is why special

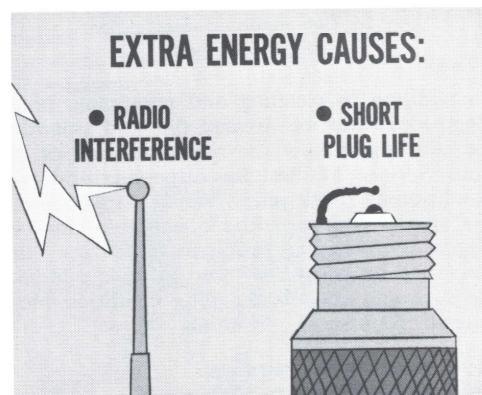

Fig. 25—Excess electrical energy can cause problems

resistance-type ignition cables are used instead of cables with ordinary metallic conductors.

The resistance built into those radio-type cables suppresses the extra energy that isn't needed for good ignition. This reduces radio interference and increases plug life. Be sure and use the recommended ignition cables. Unauthorized cables can only cause radio and ignition trouble.

#### PLUGS DO BECOME WORN

Although the resistance-type ignition cables extend plug life, it is normal for spark plug gap to increase about .001" every 1,000 miles of driving. Plug electrodes become rounded and this, in combination with gap growth, increases the voltage required for good ignition. That's why plugs must be reconditioned or replaced periodically.

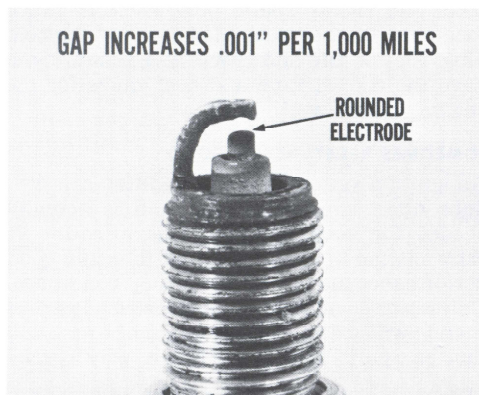

Fig. 26—Gap growth increases ignition voltage requirements

In addition to cleaning and regapping, plug electrodes must be dressed flat and smooth. Be sure and follow the recommendations in your Service Manual for inspecting and reconditioning spark plugs. Visual inspection of the spark plugs provides a valuable clue to engine performance problems which may or may not be caused by the ignition system. Be sure and consult the plug condition pictures in your Service Manuals.

#### PLUG TESTERS SOMETIMES FIB

Many perfectly good spark plugs are scrapped by mechanics who don't know how to use a



Fig. 27—Plug testers sometimes condemn good plugs

compression-type tester. Here are a few facts about spark plugs and plug testers that are worth remembering.

Under actual operating conditions in the engine, plug tip temperatures average about 1,000°F. And, as was pointed out earlier, a spark jumps the gap more easily from a hot electrode. In the plug tester, the electrode is relatively cold so the plug won't "fire" as easily as it would in the engine.

Furthermore, in the engine the air-fuel mixture provides a much better conductor than the dry air gap in the plug tester. More voltage is required to send a spark across this air gap. Also, under operating conditions, ignition usually occurs before the piston reaches top dead center . . . before peak compression pressure is reached. That means the plug doesn't actually have to fire at peak compression pressure.

#### MAKE YOUR TESTER TELL THE TRUTH

There is a practical way to use a compression-type spark plug tester. Here's what to do. Install a brand-new plug of the same type as the reconditioned one to be tested in your compression-type tester. Increase the pressure until the new plug no longer fires. Next, install the reconditioned plug and test it to find the maximum pressure at which it will fire. If the reconditioned plug will fire at a pressure that is at least 70% as high as the maximum pressure for a new plug, it is useable and will provide good ignition. In other words, if the used plug will fire at a pressure that is as much as 30% less than a new plug, it is okay.

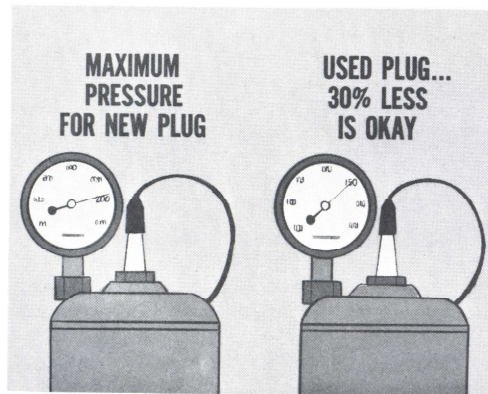

Fig. 28—Compare the reconditioned plug with a new plug

#### SPARK PLUG AS A CURE-ALL

All too often new spark plugs are installed without attempting to diagnose the actual cause of hard starting or engine performance problems. If a spark plug fails to fire because of other ignition problems, the condition may be temporarily helped by installing new plugs. However, this won't correct the basic problem and the customer will soon be back with the same old problem. It pays to diagnose the condition and correct the basic problem.

#### IGNITION CABLES AND INDUCTION FIRING

If the ignition cables aren't properly routed, they will unnecessarily be subjected to oil spillage, engine heat and possible mechanical damage. In addition, current flow through the

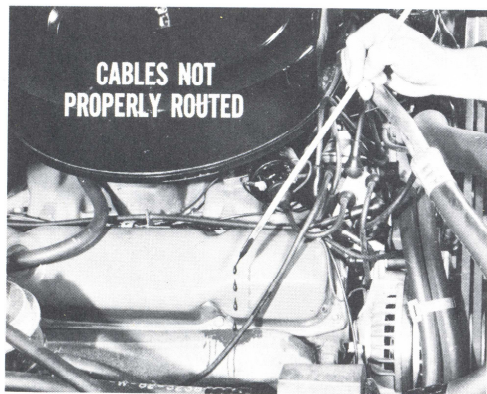

Fig. 29—Route cables correctly to avoid damage

ignition cables sets up a magnetic field which is strong enough to cause cross-firing. This is sometimes referred to as induction firing because the magnetic field around one cable can induce enough voltage in an adjacent cable to cause cross-firing. This is most apt to happen if two cables leading to cylinders that follow each other in the firing order are close to each other and parallel.

Ignition cable routing and brackets for retaining these cables are provided on all engines. Cables should always be reinstalled in their brackets. Here are three things that can be done to eliminate cross-firing.

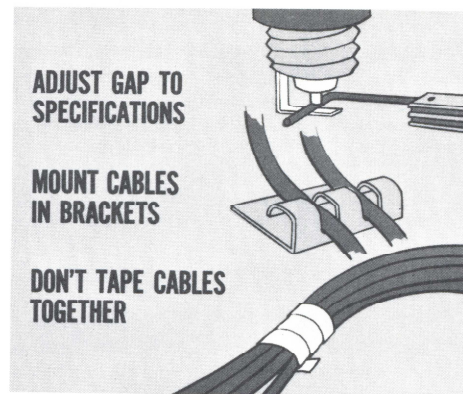
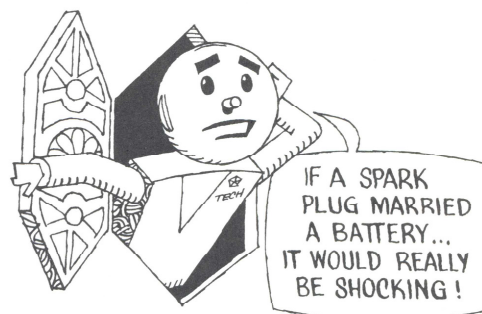

Fig. 30—To avoid induction or cross-firing

Adjust spark plug gap to specifications and file the electrodes square and flat to reduce the voltage required to fire them. Route the cables properly and mount them in their brackets. Never tape or bind cables together in a bundle.



**IGNITION  
SYSTEM  
DIAGNOSIS**

An ignition system troubleshooting chart won't solve all of your diagnosis problems for you but it can be a very useful reminder of things to look for when you have a specific performance problem. The following summary of problems and things to do to locate the cause of these problems will help jog your memory when troubleshooting engine performance complaints. This listing of problems and what to do about them assumes that you have eliminated the fuel system as the primary cause of trouble. In some cases, it will help you decide whether the trouble is in the fuel system or in the ignition system.

**PROBLEM:** *Engine cranks but won't start.*

**WHAT TO DO:** Remove a spark plug wire and check spark intensity while cranking. If there is no spark or spark is weak, connect a voltmeter to the battery terminal of the ignition coil and check voltage while cranking. If voltage is  $9\frac{1}{2}$  or higher, check ignition points and condenser. If these are okay, check the entire secondary circuit. If voltage is less than  $9\frac{1}{2}$ , test battery and check for excessive resistance in the primary circuit.

**PROBLEM:** *Engine starts but will not run when ignition key is released to "RUN" position.*

**WHAT TO DO:** Check for an open ballast resistor. If resistor is okay, check for a defective ignition switch or a loose connection in the ignition "RUN" circuit. Check connections at the bulkhead disconnect.

**PROBLEM:** *Intermittent engine stalling or cutting out when car is being driven.*

**WHAT TO DO:** Check for a loose ignition connection, particularly at the bulkhead disconnect and test the ignition switch. Check distributor for internal primary ground. Check for poor ground connection between distributor and engine block.

**PROBLEM:** *Engine is rough at idle speeds.*

**WHAT TO DO:** Check idle speed, ignition timing and ignition dwell. If these are okay, check spark plug condition and gap.

**PROBLEM:** *Sluggish or poor acceleration performance.*

**WHAT TO DO:** Check spark intensity, ignition timing, point dwell and condition of the distributor breaker points. If these are okay, inspect the spark plugs and if necessary, remove and bench-test the distributor.

**PROBLEM:** *Power loss or poor performance under all operating conditions.*

**WHAT TO DO:** Check ignition timing and dwell. Check cranking voltage. Check the secondary circuit for leaks or high resistance. Inspect the spark plugs. Remove and bench-test the distributor.

**PROBLEM:** *Misfiring or cross-firing.*

**WHAT TO DO:** Check the routing of all secondary ignition cables, the condition of these cables and the cable connections at coil tower and distributor towers. Next, inspect the distributor points and the spark plugs. If trouble persists, bench-test the distributor.